

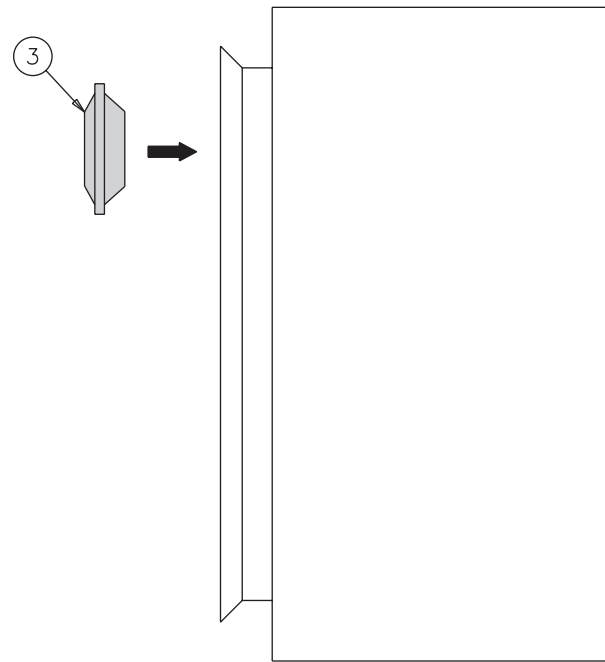







**Pentair**  
Technical Products

**Hoffman**

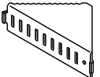

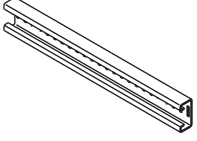
1  (4x)	3/8-16x.75	2  (4x)
3  (4x)		4  (2x)
5  (4x)		6  (4x)
7  (2x)		8  (4x)

